

# 1.4MHz High Efficiency Monolithic Synchronous Step-Down Regulator

## FEATURES

- **High Efficiency: Up to 95%**
- **Very Low Quiescent Current: Only 10 $\mu$ A During Operation**
- **600mA Output Current at  $V_{IN} = 3.3V$**
- **2.65V to 6V Input Voltage Range**
- **1.4MHz Constant Frequency Operation**
- **No Schottky Diode Required**
- **Low Dropout Operation: 100% Duty Cycle**
- Synchronizable from 1MHz to 1.7MHz
- Selectable Burst Mode<sup>®</sup> Operation or Pulse Skipping Mode
- 0.8V Reference Allows Low Output Voltages
- Shutdown Mode Draws < 1 $\mu$ A Supply Current
- $\pm 2\%$  Output Voltage Accuracy
- Current Mode Control for Excellent Line and Load Transient Response
- Overcurrent and Overtemperature Protected
- Available in 8-Lead MSOP Package

## APPLICATIONS

- Cellular Telephones
- Wireless and DSL Modems
- Personal Information Appliances
- Portable Instruments
- Distributed Power Systems
- Battery-Powered Equipment

## DESCRIPTION

The LTC<sup>®</sup>3404 is a high efficiency monolithic synchronous buck regulator using a constant frequency, current mode architecture. Supply current during operation is only 10 $\mu$ A and drops to < 1 $\mu$ A in shutdown. The 2.65V to 6V input voltage range makes the LTC3404 ideally suited for single Li-Ion battery-powered applications. 100% duty cycle provides low dropout operation, extending battery life in portable systems.

Switching frequency is internally set at 1.4MHz, allowing the use of small surface mount inductors and capacitors. For noise sensitive applications the LTC3404 can be externally synchronized from 1MHz to 1.7MHz. Burst Mode operation is inhibited during synchronization or when the SYNC/MODE pin is pulled low, preventing low frequency ripple from interfering with audio circuitry.

The internal synchronous switch increases efficiency and eliminates the need for an external Schottky diode. Low output voltages are easily supported with the 0.8V feedback reference voltage. The LTC3404 is available in a space saving 8-lead MSOP package.

For higher input voltage (11V abs max) applications, refer to the LTC1877 data sheet.

LT, LT, LTC and LTM are registered trademarks of Linear Technology Corporation. Burst Mode is a registered trademark of Linear Technology Corporation. All other trademarks are the property of their respective owners.

## TYPICAL APPLICATION

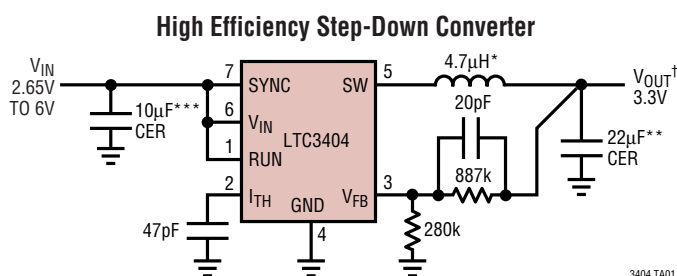

- \*TOKO D52LC A914BYW-4R7M
- \*\*TAIYO-YUDEN CERAMIC JMK325BJ226MM
- \*\*\*TAIYO-YUDEN CERAMIC LMK325BJ106MN
- <sup>†</sup> $V_{OUT}$  CONNECTED TO  $V_{IN}$  FOR  $2.65V < V_{IN} < 3.3V$

3404 TA01

**Efficiency vs Output Load Current**

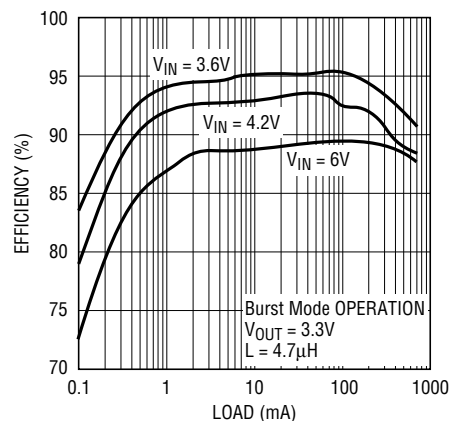

3404 TA02

## ABSOLUTE MAXIMUM RATINGS

(Note 1)

Input Supply Voltage ( $V_{IN}$ )	-0.3V to 7V
$I_{TH}$ , PLL LPF Voltage	-0.3V to 2.7V
RUN, $V_{FB}$ Voltages	-0.3V to $V_{IN}$
SYNC/MODE Voltage	-0.3V to $V_{IN}$
SW Voltage (DC)	-0.3V to ( $V_{IN} + 0.3V$ )
P-Channel MOSFET Source Current (DC)	800mA
N-Channel MOSFET Sink Current (DC)	800mA
Peak SW Sink and Source Current	1.5A
Operating Temperature Range (Note 2)	
LTC3404E/LTC3404I	-40°C to 85°C
LTC3404MP	-55°C to 125°C
Junction Temperature (Note 3)	125°C
Storage Temperature Range	-65°C to 150°C
Lead Temperature (Soldering, 10 sec)	300°C

## PACKAGE/ORDER INFORMATION

<p>MS8 PACKAGE 8-LEAD PLASTIC MSOP <math>T_{JMAX} = 125^{\circ}C</math>, <math>\theta_{JA} = 125^{\circ}C/W</math></p>	
ORDER PART NUMBER	MS8 PART MARKING
LTC3404EMS8	LTKR
LTC3404IMS8	LTCJR
LTC3404MPMS8	LTCXG
<b>Order Options</b> Tape and Reel: Add #TR Lead Free: Add #PBF Lead Free Tape and Reel: Add #TRPBF Lead Free Part Marking: <a href="http://www.linear.com/leadfree/">http://www.linear.com/leadfree/</a>	

Consult LTC Marketing for parts specified with wider operating temperature ranges.

## ELECTRICAL CHARACTERISTICS

The ● denotes specifications which apply over -40°C to 85°C, otherwise specifications are  $T_A = 25^{\circ}C$ .  
 $V_{IN} = 3.6V$  unless otherwise specified.

SYMBOL	PARAMETER	CONDITIONS	MIN	TYP	MAX	UNITS	
$I_{VFB}$	Feedback Current	(Note 4)	●	4	30	nA	
$V_{FB}$	Regulated Output Voltage	(Note 4) $0^{\circ}C \leq T_A \leq 85^{\circ}C$ (Note 4) $-40^{\circ}C \leq T_A \leq 85^{\circ}C$	●	0.784 0.74	0.8 0.84	V V	
$\Delta V_{OVL}$	Output Overvoltage Lockout	$\Delta V_{OVL} = V_{OVL} - V_{FB}$	●	20	50 110	mV	
$\Delta V_{FB}$	Reference Voltage Line Regulation	$V_{IN} = 2.65V$ to $6V$ (Note 4)		0.05	0.2	%/V	
$V_{LOADREG}$	Output Voltage Load Regulation	Measured in Servo Loop; $V_{ITH} = 0.9V$ to $1.2V$ Measured in Servo Loop; $V_{ITH} = 1.6V$ to $1.2V$	● ●	0.1 -0.1	0.5 -0.5	% %	
$V_{IN}$	Input Voltage Range		●	2.65	6	V	
$I_Q$	Input DC Bias Current Pulse Skipping Mode Burst Mode Operation Shutdown	(Note 5) $2.65V < V_{IN} < 6V$ , $V_{SYNC/MODE} = 0V$ , $I_{OUT} = 0A$ $V_{SYNC/MODE} = V_{IN}$ , $I_{OUT} = 0A$ $V_{RUN} = 0V$ , $V_{IN} = 6V$		400 10 0	700 15 1	$\mu A$ $\mu A$ $\mu A$	
$f_{OSC}$	Oscillator Frequency	$V_{FB} = 0.8V$ $V_{FB} = 0V$	●	1.25 200	1.4 1.65	MHz kHz	
$f_{SYNC}$	SYNC Capture Range			1.0	1.7	MHz	
$I_{PLL LPF}$	Phase Detector Output Current Sinking Capability Sourcing Capability	$f_{PLLIN} < f_{OSC}$ $f_{PLLIN} > f_{OSC}$	● ●	6 -6	20 -20	40 -40	$\mu A$ $\mu A$
$R_{PFET}$	$R_{DS(ON)}$ of P-Channel MOSFET	$I_{SW} = 100mA$		0.5	0.7	$\Omega$	
$R_{NFET}$	$R_{DS(ON)}$ of N-Channel MOSFET	$I_{SW} = -100mA$		0.6	0.8	$\Omega$	
$I_{PK}$	Peak Inductor Current	$V_{IN} = 3.3V$ , $V_{FB} = 0.7V$ , Duty Cycle < 35%		0.8	1.0 1.25	A	
$I_{LSW}$	SW Leakage	$V_{RUN} = 0V$ , $V_{SW} = 0V$ or $6V$ , $V_{IN} = 6V$			$\pm 0.01$ $\pm 1$	$\mu A$	
$V_{SYNC/MODE}$	SYNC/MODE Threshold	$V_{SYNC/MODE}$ Rising	●	0.3	1.0 1.5	V	
$I_{SYNC/MODE}$	SYNC/MODE Leakage Current			$\pm 0.01$	$\pm 1$	$\mu A$	
$V_{RUN}$	RUN Threshold	$V_{RUN}$ Rising	●	0.3	0.7 1.5	V	
$I_{RUN}$	RUN Input Current			$\pm 0.01$	$\pm 1$	$\mu A$	

## ELECTRICAL CHARACTERISTICS

The ● denotes specifications which apply over  $-55^{\circ}\text{C}$  to  $125^{\circ}\text{C}$ , otherwise specifications are  $T_A = 25^{\circ}\text{C}$ .  
 $V_{\text{IN}} = 3.6\text{V}$  unless otherwise specified.

SYMBOL	PARAMETER	CONDITIONS	MIN	TYP	MAX	UNITS
$I_{\text{VFB}}$	Feedback Current	(Note 4)		4	30	nA
$V_{\text{FB}}$	Regulated Output Voltage	(Note 4) $0^{\circ}\text{C} \leq T_A \leq 125^{\circ}\text{C}$ (Note 4) $-55^{\circ}\text{C} \leq T_A \leq 125^{\circ}\text{C}$	0.784 0.74	0.8 0.8	0.816 0.84	V V
$\Delta V_{\text{OVL}}$	Output Overvoltage Lockout	$\Delta V_{\text{OVL}} = V_{\text{OVL}} - V_{\text{FB}}$	20	50	110	mV
$\Delta V_{\text{FB}}$	Reference Voltage Line Regulation	$V_{\text{IN}} = 2.65\text{V}$ to $6\text{V}$ (Note 4)		0.05	0.2	%/V
$V_{\text{LOADREG}}$	Output Voltage Load Regulation	Measured in Servo Loop; $V_{\text{ITH}} = 0.9\text{V}$ to $1.2\text{V}$ Measured in Servo Loop; $V_{\text{ITH}} = 1.5\text{V}$ to $1.2\text{V}$		0.1 -0.1	1 -1	% %
$V_{\text{IN}}$	Input Voltage Range		2.65		6	V
$I_{\text{Q}}$	Input DC Bias Current Pulse Skipping Mode Burst Mode Operation Shutdown	(Note 5) $2.65\text{V} < V_{\text{IN}} < 6\text{V}$ , $V_{\text{SYNC/MODE}} = 0\text{V}$ , $I_{\text{OUT}} = 0\text{A}$ $V_{\text{SYNC/MODE}} = V_{\text{IN}}$ , $I_{\text{OUT}} = 0\text{A}$ $V_{\text{RUN}} = 0\text{V}$ , $V_{\text{IN}} = 6\text{V}$		400 10 0	700 15 1	$\mu\text{A}$ $\mu\text{A}$ $\mu\text{A}$
$f_{\text{OSC}}$	Oscillator Frequency	$V_{\text{FB}} = 0.8\text{V}$ $V_{\text{FB}} = 0\text{V}$	1.25	1.4 200	1.65	MHz kHz
$f_{\text{SYNC}}$	SYNC Capture Range		1.0		1.7	MHz
$I_{\text{PLL LPF}}$	Phase Detector Output Current Sinking Capability Sourcing Capability	$f_{\text{PLLIN}} < f_{\text{OSC}}$ $f_{\text{PLLIN}} > f_{\text{OSC}}$	6 -6	20 -20	40 -40	$\mu\text{A}$ $\mu\text{A}$
$R_{\text{PFET}}$	$R_{\text{DS(ON)}}$ of P-Channel MOSFET	$I_{\text{SW}} = 100\text{mA}$			0.7	$\Omega$
$R_{\text{NFET}}$	$R_{\text{DS(ON)}}$ of N-Channel MOSFET	$I_{\text{SW}} = -100\text{mA}$			0.8	$\Omega$
$I_{\text{PK}}$	Peak Inductor Current	$V_{\text{IN}} = 3.3\text{V}$ , $V_{\text{FB}} = 0.7\text{V}$ , Duty Cycle $< 35\%$ , $T_A = 125^{\circ}\text{C}$ $V_{\text{IN}} = 4\text{V}$ , $V_{\text{FB}} = 0.7\text{V}$ , Duty Cycle $< 35\%$ , $T_A = 125^{\circ}\text{C}$	0.4 0.8	1.0	1.1 1.2	A A
$I_{\text{LSW}}$	SW Leakage	$V_{\text{RUN}} = 0\text{V}$ , $V_{\text{SW}} = 0\text{V}$ or $6\text{V}$ , $V_{\text{IN}} = 6\text{V}$			$\pm 3$	$\mu\text{A}$
$V_{\text{SYNC/MODE}}$	SYNC/MODE Threshold	$V_{\text{SYNC/MODE}}$ Rising	0.3		1.5	V
$I_{\text{SYNC/MODE}}$	SYNC/MODE Leakage Current				$\pm 1$	$\mu\text{A}$
$V_{\text{RUN}}$	RUN Threshold	$V_{\text{RUN}}$ Rising	0.3		1.5	V
$I_{\text{RUN}}$	RUN Input Current				$\pm 1$	$\mu\text{A}$

**Note 1:** Stresses beyond those listed under Absolute Maximum Ratings may cause permanent damage to the device. Exposure to any Absolute Maximum Rating condition for extended periods may affect device reliability and lifetime.

**Note 2:** The LTC3404E is guaranteed to meet performance specifications from  $0^{\circ}\text{C}$  to  $85^{\circ}\text{C}$ . Specifications over the  $-40^{\circ}\text{C}$  to  $85^{\circ}\text{C}$  operating temperature range are assured by design, characterization and correlation with statistical process controls. The LTC3404I is guaranteed to meet performance specifications over the  $-40^{\circ}\text{C}$  to  $85^{\circ}\text{C}$  operating temperature range. The LTC3404MP is guaranteed to meet performance specifications over the  $-55^{\circ}\text{C}$  to  $125^{\circ}\text{C}$  operating temperature range.

**Note 3:**  $T_J$  is calculated from the ambient temperature  $T_A$  and power dissipation  $P_D$  according to the following formulas:

$$T_J = T_A + (P_D)(150^{\circ}\text{C}/\text{W})$$

**Note 4:** The LTC3404 is tested in a feedback loop which serves  $V_{\text{FB}}$  to the balance point for the error amplifier ( $V_{\text{ITH}} = 1.2\text{V}$ ).

**Note 5:** Dynamic supply current is higher due to the gate charge being delivered at the switching frequency.

# TYPICAL PERFORMANCE CHARACTERISTICS

Efficiency vs Input Voltage

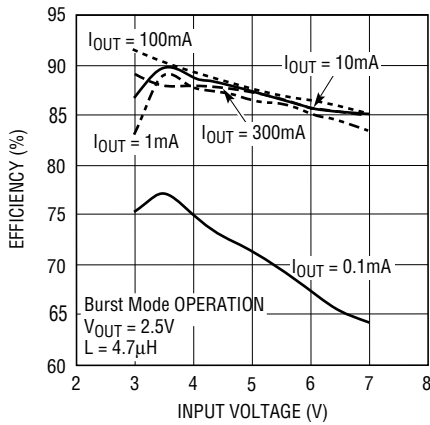

3404 G01

Efficiency vs Output Current

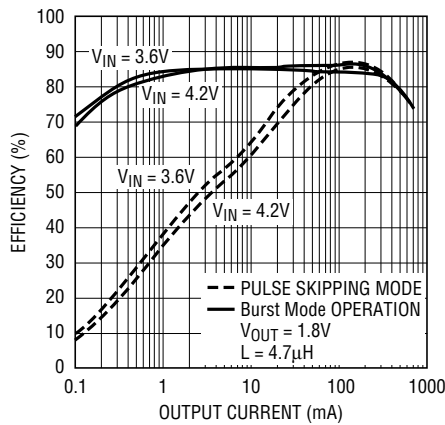

3404 G02

Efficiency vs Output Current

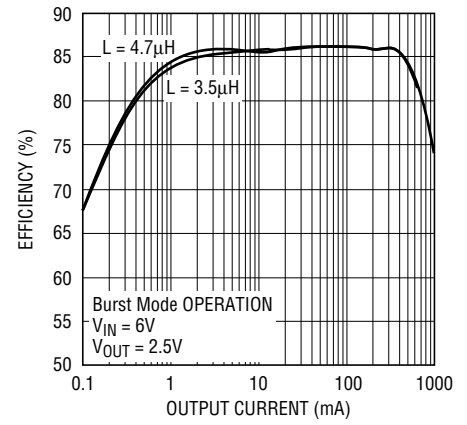

3404 G03

Efficiency vs Output Current

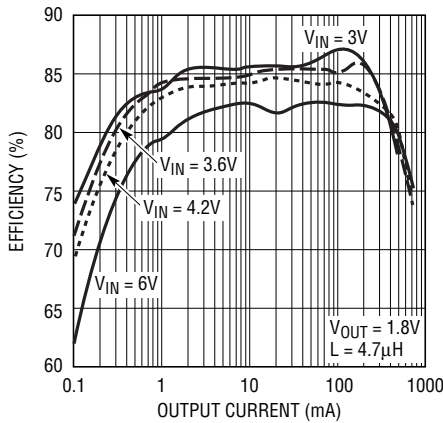

3404 G04

Efficiency vs Output Current

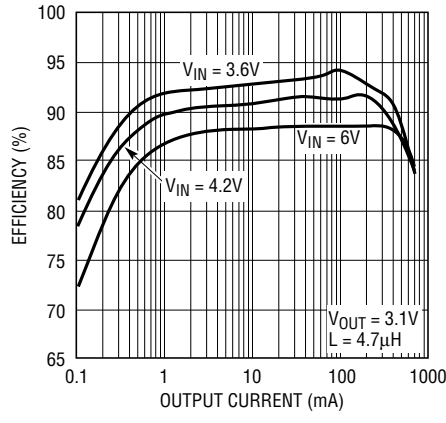

3404 G4a

Reference Voltage vs Temperature

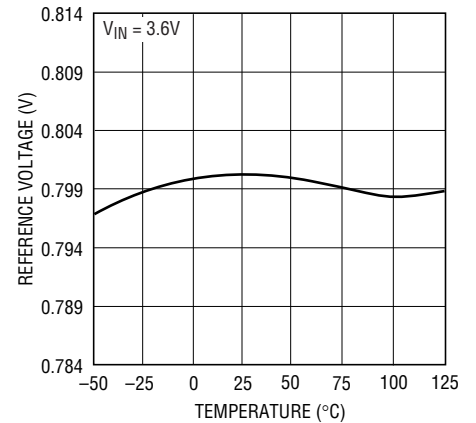

3404 G05

Oscillator Frequency vs Temperature

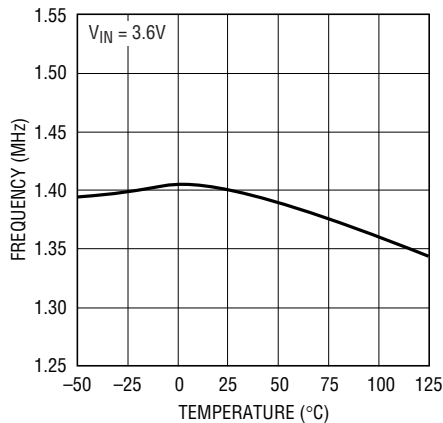

3404 G06

Oscillator Frequency vs Supply Voltage

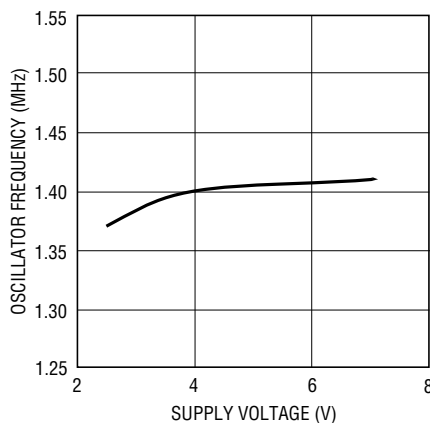

3404 G07

Output Voltage vs Load Current

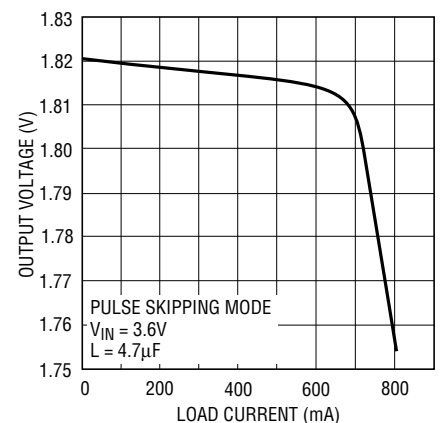

3404 G08

# TYPICAL PERFORMANCE CHARACTERISTICS

**$R_{DS(ON)}$  vs Input Voltage**

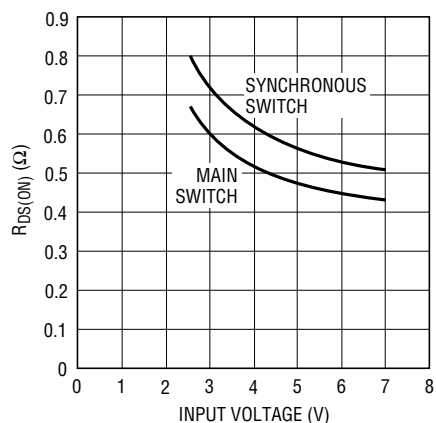

3404 G09

**$R_{DS(ON)}$  vs Temperature**

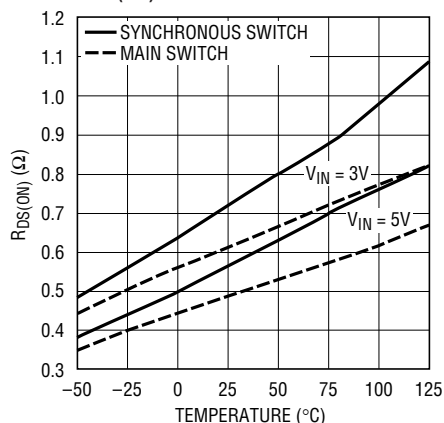

3404 G10

**DC Supply Current vs Input Voltage**

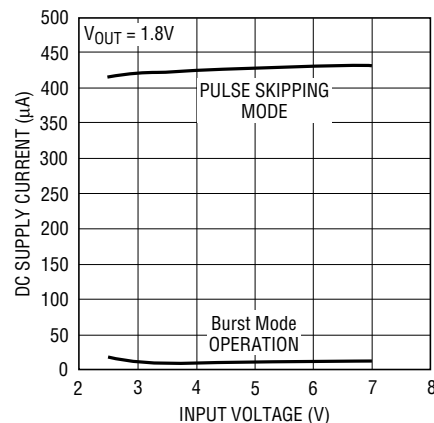

3404 G11

**DC Supply Current vs Temperature**

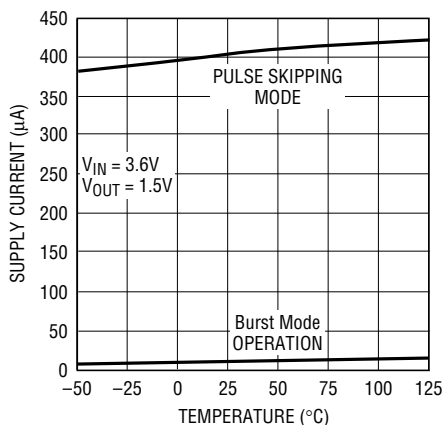

3404 G12

**Switch Leakage vs Temperature**

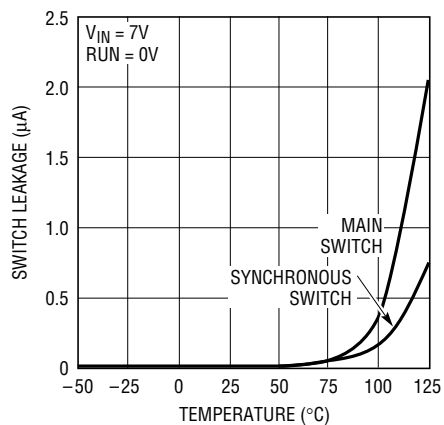

3404 G13

**Switch Leakage vs Input Voltage**

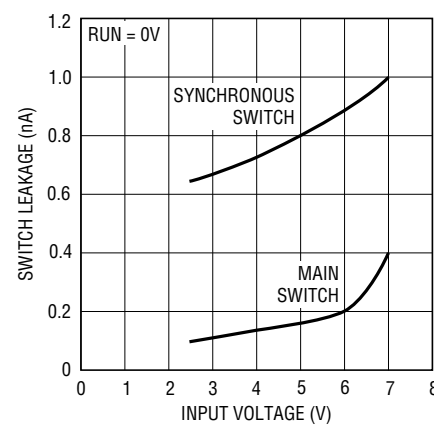

3404 G20

**Burst Mode Operation**

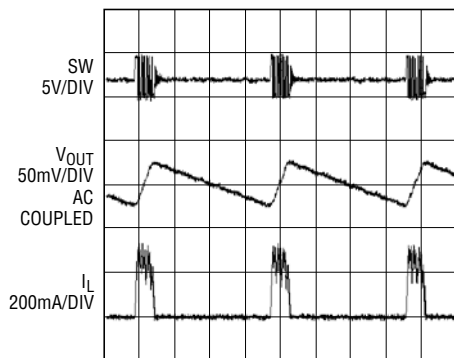

$V_{IN} = 4.2V$   $C_{IN} = 10\mu F$   
 $V_{OUT} = 1.5V$   $C_{OUT} = 22\mu F$   
 $L = 4.7\mu H$   $I_{LOAD} = 30mA$

3404 G14

**Pulse Skipping Mode Operation**

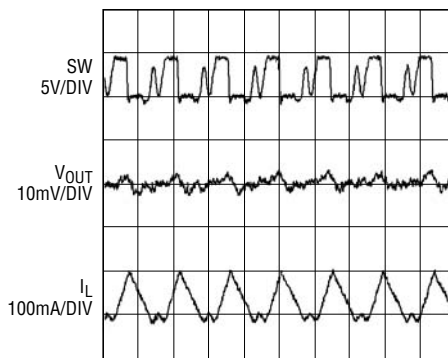

$V_{IN} = 4.2V$   $C_{IN} = 10\mu F$   
 $V_{OUT} = 1.5V$   $C_{OUT} = 22\mu F$   
 $L = 4.7\mu H$   $I_{LOAD} = 30mA$

3404 G15

**Start-Up from Shutdown**

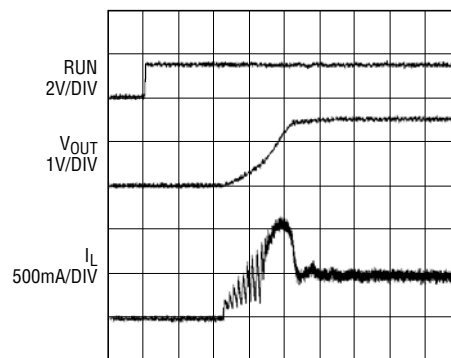

$V_{IN} = 3.6V$   $C_{IN} = 10\mu F$   
 $V_{OUT} = 1.5V$   $C_{OUT} = 22\mu F$   
 $L = 4.7\mu H$   $I_{LOAD} = 500mA$

3404 G16

## TYPICAL PERFORMANCE CHARACTERISTICS

Load Step Response

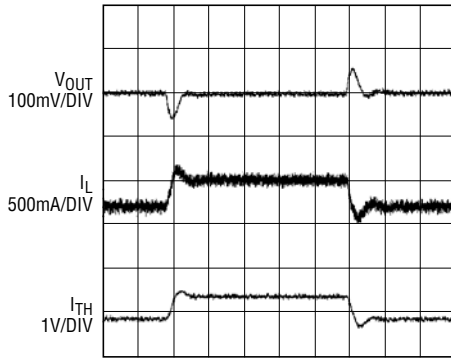

40 $\mu$ s/DIV  
 $V_{IN} = 3.6V$   $C_{IN} = 10\mu F$   
 $V_{OUT} = 1.5V$   $C_{OUT} = 22\mu F$   
 $L = 4.7\mu H$   $I_{LOAD} = 200mA$  TO 500mA 3404 G17  
 PULSE SKIPPING MODE

Load Step Response

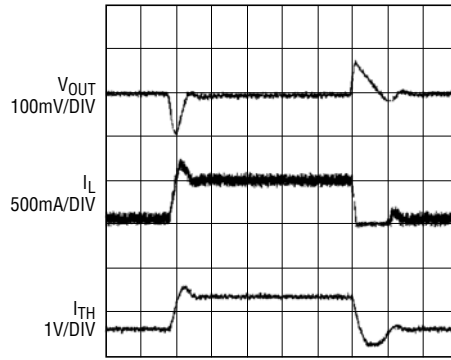

40 $\mu$ s/DIV  
 $V_{IN} = 3.6V$   $C_{IN} = 10\mu F$   
 $V_{OUT} = 1.5V$   $C_{OUT} = 22\mu F$   
 $L = 4.7\mu H$   $I_{LOAD} = 50mA$  TO 500mA 3404 G18  
 PULSE SKIPPING MODE

Load Step Response

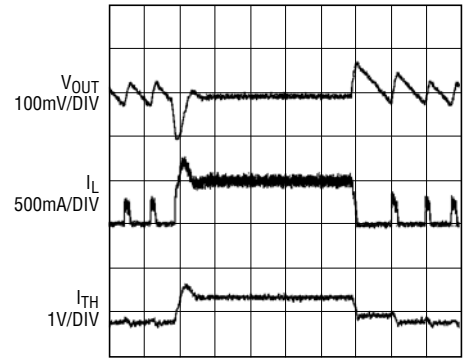

40 $\mu$ s/DIV  
 $V_{IN} = 3.6V$   $C_{IN} = 10\mu F$   
 $V_{OUT} = 1.5V$   $C_{OUT} = 22\mu F$   
 $L = 4.7\mu H$   $I_{LOAD} = 50mA$  TO 500mA 3404 G19  
 Burst Mode OPERATION

## PIN FUNCTIONS

**RUN (Pin 1):** Run Control Input. Forcing this pin below 0.4V shuts down the LTC3404. In shutdown all functions are disabled drawing  $<1\mu A$  supply current. Forcing this pin above 1.2V enables the LTC3404. Do not leave RUN floating.

**$I_{TH}$  (Pin 2):** Error Amplifier Compensation Point. The current comparator threshold increases with this control voltage. Nominal voltage range for this pin is from 0.5V to 1.9V.

**$V_{FB}$  (Pin 3):** Feedback Pin. Receives the feedback voltage from an external resistive divider across the output.

**GND (Pin 4):** Ground Pin.

**SW (Pin 5):** Switch Node Connection to Inductor. This pin

connects to the drains of the internal main and synchronous power MOSFET switches.

**$V_{IN}$  (Pin 6):** Main Supply Pin. Must be closely decoupled to GND, Pin 4.

**SYNC/MODE (Pin 7):** External Clock Synchronization and Mode Select Input. To synchronize with an external clock, apply a clock with a frequency between 1MHz and 1.7MHz. To select Burst Mode operation, tie to  $V_{IN}$ . Grounding this pin selects pulse skipping mode. Do not leave this pin floating.

**PLL LPF (Pin 8):** Output of the Phase Detector and Control Input of Oscillator. Connect a series RC lowpass network from this pin to ground if externally synchronized. If unused, this pin may be left open.



## OPERATION

When the converter is in Burst Mode operation, the peak current of the inductor is set to approximately 250mA, even though the voltage at the  $I_{TH}$  pin indicates a lower value. The voltage at the  $I_{TH}$  pin drops when the inductor's average current is greater than the load requirement. As the  $I_{TH}$  voltage drops below approximately 0.55V, the BURST comparator trips, causing the internal sleep line to go high and forces off both power MOSFETs. The  $I_{TH}$  pin is then disconnected from the output of the EA amplifier and held a diode voltage (0.7V) above ground.

In sleep mode, both power MOSFETs are held off and a majority of the internal circuitry is partially turned off, reducing the quiescent current to 10 $\mu$ A. The load current is now being supplied solely from the output capacitor. When the output voltage drops, the  $I_{TH}$  pin reconnects to the output of the EA amplifier and the top MOSFET is again turned on and this process repeats.

### Short-Circuit Protection

When the output is shorted to ground, the frequency of the oscillator is reduced to about 200kHz, 1/7 the nominal frequency. This frequency foldback ensures that the inductor current has ample time to decay, thereby preventing runaway. The oscillator's frequency will progressively increase to 1.4MHz (or the synchronized frequency) when  $V_{FB}$  rises above 0.3V.

### Frequency Synchronization

A phase-locked loop (PLL) is available on the LTC3404 to allow the internal oscillator to be synchronized to an external source connected to the SYNC/MODE pin. The output of the phase detector at the PLL LPF pin operates over a 0V to 2.4V range corresponding to 1MHz to 1.7MHz. When locked, the PLL aligns the turn-on of the top MOSFET to the rising edge of the synchronizing signal.

When the LTC3404 is clocked by an external source, Burst Mode operation is disabled; the LTC3404 then operates in PWM pulse skipping mode. In this mode, when the output load is very low, current comparator  $I_{COMP}$  may remain tripped for several cycles and force the main switch to stay off for the same number of cycles. Increasing the output load slightly allows constant frequency PWM operation to resume. This mode exhibits low output ripple as well as

low audio noise and reduced RF interference while providing reasonable low current efficiency.

Frequency synchronization is inhibited when the feedback voltage  $V_{FB}$  is below 0.6V. This prevents the external clock from interfering with the frequency foldback for short-circuit protection.

### Dropout Operation

When the input supply voltage decreases toward the output voltage, the duty cycle increases toward the maximum on-time. Further reduction of the supply voltage forces the main switch to remain on for more than one cycle until it reaches 100% duty cycle. The output voltage will then be determined by the input voltage minus the voltage drop across the internal P-channel MOSFET and the inductor.

### Low Supply Operation

The LTC3404 is designed to operate down to an input supply voltage of 2.65V although the maximum allowable output current is reduced at this low voltage. Figure 1 shows the reduction in the maximum output current as a function of input voltage for various output voltages.

Another important detail to remember is that at low input supply voltages, the  $R_{DS(ON)}$  of the P-channel switch increases. Therefore, the user should calculate the power dissipation when the LTC3404 is used at 100% duty cycle with a low input voltage (see Thermal Considerations in the Applications Information section).

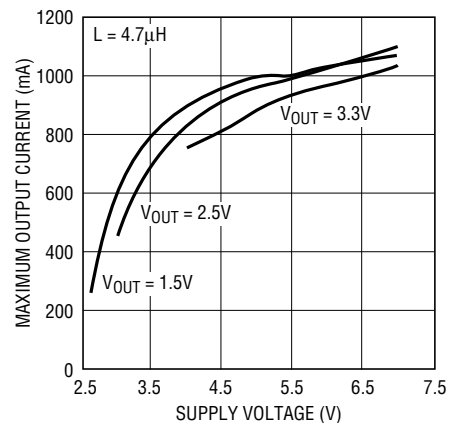

3404-F01

Figure 1. Maximum Output Current vs Input Voltage



## OPERATION

### Slope Compensation and Inductor Peak Current

Slope compensation provides stability in constant frequency architectures by preventing subharmonic oscillations at high duty cycles. It is accomplished internally by adding a compensating ramp to the inductor current signal at duty cycles in excess of 40%. As a result, the maximum inductor peak current is reduced for duty cycles >40%. This is shown in the decrease of the inductor peak current as a function of duty cycle graph in Figure 2.

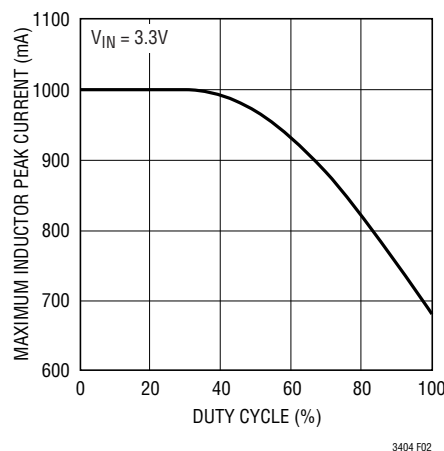

Figure 2. Maximum Inductor Peak Current vs Duty Cycle

## APPLICATIONS INFORMATION

The basic LTC3404 application circuit is shown on the first page. External component selection is driven by the load requirement and begins with the selection of L followed by  $C_{IN}$  and  $C_{OUT}$ .

### Inductor Value Calculation

The inductor selection will depend on the operating frequency of the LTC3404. The internal nominal frequency is 1.4MHz, but can be externally synchronized from 1MHz to 1.7MHz.

The operating frequency and inductor selection are inter-related in that higher operating frequencies allow the use of smaller inductor and capacitor values. However, operating at a higher frequency generally results in lower efficiency because of increased internal gate charge losses.

The inductor value has a direct effect on ripple current. The ripple current  $\Delta I_L$  decreases with higher inductance or frequency and increases with higher  $V_{IN}$  or  $V_{OUT}$ .

$$\Delta I_L = \frac{1}{(f)(L)} V_{OUT} \left( 1 - \frac{V_{OUT}}{V_{IN}} \right) \quad (1)$$

Accepting larger values of  $\Delta I_L$  allows the use of smaller inductors, but results in higher output voltage ripple and greater core losses. A reasonable starting point for setting ripple current is  $\Delta I_L = 0.4(I_{MAX})$ .

The inductor value also has an effect on Burst Mode operation. The transition to low current operation begins when the inductor current peaks fall to approximately 250mA. Lower inductor values (higher  $\Delta I_L$ ) will cause this to occur at lower load currents, which can cause a dip in efficiency in the upper range of low current operation. In Burst Mode operation, lower inductance values will cause the burst frequency to increase.

### Inductor Core Selection

Once the value for L is known, the type of inductor must be selected. High efficiency converters generally cannot afford the core loss found in low cost powdered iron cores, forcing the use of more expensive ferrite, molypermalloy, or Kool M $\mu$ <sup>®</sup> cores. Actual core loss is independent of core size for a fixed inductor value, but it is very dependent on inductance selected. As inductance increases, core losses go down. Unfortunately, increased inductance requires more turns of wire and therefore copper losses will increase.

Ferrite designs have very low core losses and are preferred at high switching frequencies, so design goals can concentrate on copper loss and preventing saturation. Ferrite core material saturates “hard,” which means that inductance collapses abruptly when the peak design current is exceeded. This results in an abrupt increase in

## APPLICATIONS INFORMATION

inductor ripple current and consequent output voltage ripple. Do not allow the core to saturate!

Kool M $\mu$  (from Magnetics, Inc.) is a very good, low loss core material for toroids with a “soft” saturation characteristic. Molypermalloy is slightly more efficient at high (>200kHz) switching frequencies but quite a bit more expensive. Toroids are very space efficient, especially when you can use several layers of wire, while inductors wound on bobbins are generally easier to surface mount. New designs for surface mount inductors are available from Coiltronics, Coilcraft, Dale and Sumida.

### C<sub>IN</sub> and C<sub>OUT</sub> Selection

In continuous mode, the source current of the top MOSFET is a square wave of duty cycle  $V_{OUT}/V_{IN}$ . To prevent large voltage transients, a low ESR input capacitor sized for the maximum RMS current must be used. The maximum RMS capacitor current is given by:

$$C_{IN} \text{ required } I_{RMS} \cong I_{OMAX} \frac{[V_{OUT}(V_{IN} - V_{OUT})]^{1/2}}{V_{IN}}$$

This formula has a maximum at  $V_{IN} = 2V_{OUT}$ , where  $I_{RMS} = I_{OUT}/2$ . This simple worst-case condition is commonly used for design because even significant deviations do not offer much relief. Note that the capacitor manufacturer’s ripple current ratings are often based on 2000 hours of life. This makes it advisable to further derate the capacitor, or choose a capacitor rated at a higher temperature than required. Several capacitors may also be paralleled to meet size or height requirements in the design. Always consult the manufacturer if there is any question.

The selection of  $C_{OUT}$  is driven by the required effective series resistance (ESR). Typically, once the ESR requirement is satisfied, the capacitance is adequate for filtering. The output ripple  $\Delta V_{OUT}$  is determined by:

$$\Delta V_{OUT} \cong \Delta I_L \left( ESR + \frac{1}{8fC_{OUT}} \right)$$

where  $f$  = operating frequency,  $C_{OUT}$  = output capacitance and  $\Delta I_L$  = ripple current in the inductor. The output ripple

is highest at maximum input voltage since  $\Delta I_L$  increases with input voltage. For the LTC3404, the general rule for proper operation is:

$$C_{OUT} \text{ required } ESR < 0.25\Omega$$

The choice of using a smaller output capacitance increases the output ripple voltage due to the frequency dependent term but can be compensated for by using capacitor(s) of very low ESR to maintain low ripple voltage. The  $I_{TH}$  pin compensation components can be optimized to provide stable high performance transient response regardless of the output capacitor selected.

ESR is a direct function of the volume of the capacitor. Manufacturers such as Taiyo-Yuden, AVX, Kemet, Sprague and Sanyo should be considered for high performance capacitors. The POSCAP solid electrolytic chip capacitor available from Sanyo is an excellent choice for output bulk capacitors due to its low ESR/size ratio. Once the ESR requirement for  $C_{OUT}$  has been met, the RMS current rating generally far exceeds the  $I_{RIPPLE(P-P)}$  requirement.

When using tantalum capacitors, it is critical that they are surge tested for use in switching power supplies. A good choice is the AVX TPS series of surface mount tantalum, available in case heights ranging from 2mm to 4mm. Other capacitor types include KEMET T510 and T495 series and Sprague 593D and 595D series. Consult the manufacturer for other specific recommendations.

### Output Voltage Programming

The output voltage is set by a resistive divider according to the following formula:

$$V_{OUT} = 0.8V \left( 1 + \frac{R2}{R1} \right) \quad (2)$$

The external resistive divider is connected to the output, allowing remote voltage sensing as shown in Figure 3.

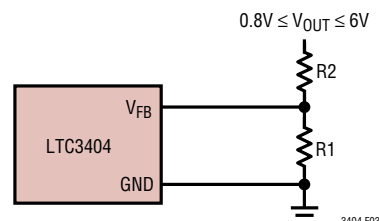

Figure 3. Setting the LTC3404 Output Voltage

3404fb

## APPLICATIONS INFORMATION

### Phase-Locked Loop and Frequency Synchronization

The LTC3404 has an internal voltage-controlled oscillator and phase detector comprising a phase-locked loop. This allows the top MOSFET turn-on to be locked to the rising edge of an external frequency source. The frequency range of the voltage-controlled oscillator is 1MHz to 1.7MHz. The phase detector used is an edge sensitive digital type that provides zero degrees phase shift between the external and internal oscillators. This type of phase detector will not lock up on input frequencies close to the harmonics of the  $V_{CO}$  center frequency. The PLL hold-in range  $\Delta f_H$  is equal to the capture range,  $\Delta f_H = \Delta f_C = 300\text{kHz}$  and  $-400\text{kHz}$ .

The output of the phase detector is a pair of complementary current sources charging or discharging the external filter network on the PLL LPF pin. The relationship

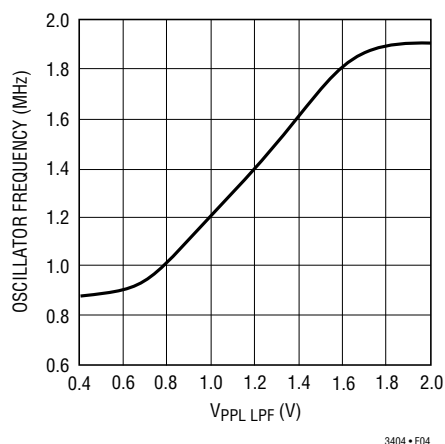

Figure 4. Relationship Between Oscillator Frequency and Voltage at PLL LPF Pin

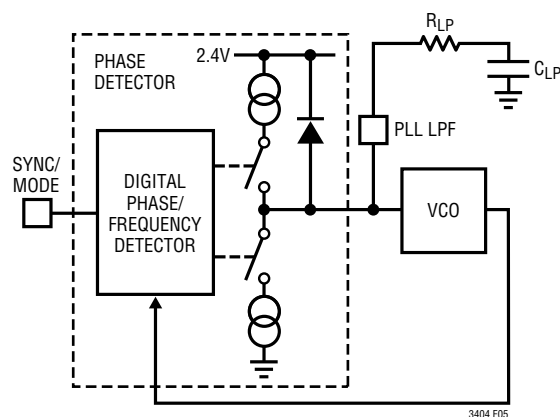

Figure 5. Phase-Locked Loop Block Diagram

between the voltage on the PLL LPF pin and operating frequency is shown in Figure 4. A simplified block diagram is shown in Figure 5.

If the external frequency ( $V_{\text{SYNC/MODE}}$ ) is greater than 1.4MHz, the center frequency, current is sourced continuously, pulling up the PLL LPF pin. When the external frequency is less than 1.4MHz, current is sunk continuously, pulling down the PLL LPF pin. If the external and internal frequencies are the same but exhibit a phase difference, the current sources turn on for an amount of time corresponding to the phase difference. Thus the voltage on the PLL LPF pin is adjusted until the phase and frequency of the external and internal oscillators are identical. At this stable operating point the phase comparator output is high impedance and the filter capacitor  $C_{LP}$  holds the voltage.

The loop filter components  $C_{LP}$  and  $R_{LP}$  smooth out the current pulses from the phase detector and provide a stable input to the voltage controlled oscillator. The filter component's  $C_{LP}$  and  $R_{LP}$  determine how fast the loop acquires lock. Typically  $R_{LP} = 10\text{k}$  and  $C_{LP}$  is 2200pF to 0.01 $\mu\text{F}$ . When not synchronized to an external clock, the internal connection to the VCO is disconnected. This disallows setting the internal oscillator frequency by a DC voltage on the  $V_{\text{PLL LPF}}$  pin.

### Efficiency Considerations

The efficiency of a switching regulator is equal to the output power divided by the input power times 100%. It is often useful to analyze individual losses to determine what is limiting the efficiency and which change would produce the most improvement. Efficiency can be expressed as:

$$\text{Efficiency} = 100\% - (L1 + L2 + L3 + \dots)$$

where L1, L2, etc. are the individual losses as a percentage of input power.

Although all dissipative elements in the circuit produce losses, two main sources usually account for most of the losses in LTC3404 circuits:  $V_{\text{IN}}$  quiescent current and  $i^2R$  losses. The  $V_{\text{IN}}$  quiescent current loss dominates the efficiency loss at very low load currents whereas the  $i^2R$  loss dominates the efficiency loss at medium to high load currents. In a typical efficiency plot, the efficiency curve at

## APPLICATIONS INFORMATION

very low load currents can be misleading since the actual power lost is of no consequence as illustrated in Figure 6.

1. The  $V_{IN}$  quiescent current is due to two components: the DC bias current as given in the electrical characteristics and the internal main switch and synchronous switch gate charge currents. The gate charge current results from switching the gate capacitance of the internal power MOSFET switches. Each time the gate is switched from high to low to high again, a packet of charge  $dQ$  moves from  $V_{IN}$  to ground. The resulting  $dQ/dt$  is the current out of  $V_{IN}$  that is typically larger than the DC bias current. In continuous mode,  $I_{GATECHG} = f(Q_T + Q_B)$  where  $Q_T$  and  $Q_B$  are the gate charges of the internal top and bottom switches. Both the DC bias and gate charge losses are proportional to  $V_{IN}$  and thus their effects will be more pronounced at higher supply voltages.

2.  $I^2R$  losses are calculated from the resistances of the internal switches,  $R_{SW}$ , and external inductor  $R_L$ . In continuous mode the average output current flowing through inductor  $L$  is “chopped” between the main switch and the synchronous switch. Thus, the series resistance looking into the SW pin is a function of both top and bottom MOSFET  $R_{DS(ON)}$  and the duty cycle (DC) as follows:

$$R_{SW} = (R_{DS(ON)TOP})(DC) + (R_{DS(ON)BOT})(1 - DC)$$

The  $R_{DS(ON)}$  for both the top and bottom MOSFETs can be obtained from the Typical Performance Characteristics curves. Thus, to obtain  $I^2R$  losses, simply add  $R_{SW}$  to  $R_L$  and multiply the result by the square of the average output current.

Other losses including  $C_{IN}$  and  $C_{OUT}$  ESR dissipative losses and inductor core losses generally account for less than 2% total additional loss.

### Thermal Considerations

In most applications the LTC3404 does not dissipate much heat due to its high efficiency. But, in applications where the LTC3404 is running at high ambient temperature with low supply voltage and high duty cycles, such as in dropout, the heat dissipated may exceed the maximum junction temperature of the part. If the junction

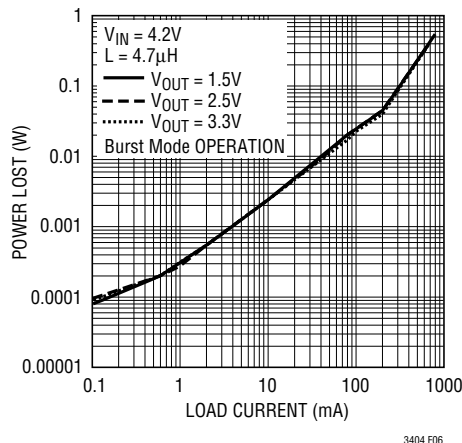

Figure 6. Power Lost vs Load Current

temperature reaches approximately 175°C, both power switches will be turned off and the SW node will become high impedance.

To avoid the LTC3404 from exceeding the maximum junction temperature, the user will need to do some thermal analysis. The goal of the thermal analysis is to determine whether the power dissipated exceeds the maximum junction temperature of the part. The temperature rise is given by:

$$T_R = (P_D)(\theta_{JA})$$

where  $P_D$  is the power dissipated by the regulator and  $\theta_{JA}$  is the thermal resistance from the junction of the die to the ambient temperature.

The junction temperature,  $T_J$ , is given by:

$$T_J = T_A + T_R$$

where  $T_A$  is the ambient temperature.

As an example, consider the LTC3404 in dropout at an input voltage of 3V, a load current of 500mA, and an ambient temperature of 70°C. From the typical performance graph of switch resistance, the  $R_{DS(ON)}$  of the P-channel switch at 70°C is approximately 0.7Ω. Therefore, power dissipated by the part is:

$$P_D = I_{LOAD}^2 \cdot R_{DS(ON)} = 0.175W$$

For the MSOP package, the  $\theta_{JA}$  is 150°C/W. Thus, the junction temperature of the regulator is:

$$T_J = 70^\circ C + (0.175)(150) = 96^\circ C$$

## APPLICATIONS INFORMATION

which is below the maximum junction temperature of 125°C.

Note that at higher supply voltages, the junction temperature is lower due to reduced switch resistance ( $R_{DS(ON)}$ ).

### Checking Transient Response

The regulator loop response can be checked by looking at the load transient response. Switching regulators take several cycles to respond to a step in load current. When a load step occurs,  $V_{OUT}$  immediately shifts by an amount equal to  $(\Delta I_{LOAD} \cdot ESR)$ , where ESR is the effective series resistance of  $C_{OUT}$ .  $\Delta I_{LOAD}$  also begins to charge or discharge  $C_{OUT}$ , which generates a feedback error signal. The regulator loop then acts to return  $V_{OUT}$  to its steady-state value. During this recovery time  $V_{OUT}$  can be monitored for overshoot or ringing that would indicate a stability problem. The internal compensation provides adequate compensation for most applications. But if additional compensation is required, the  $I_{TH}$  pin can be used for external compensation using  $R_C$ ,  $C_{C1}$  as shown in Figure 7. (The 47pF capacitor,  $C_{C2}$ , is typically needed for noise decoupling.)

A second, more severe transient is caused by switching in loads with large ( $>1\mu F$ ) supply bypass capacitors. The discharged bypass capacitors are effectively put in parallel with  $C_{OUT}$ , causing a rapid drop in  $V_{OUT}$ . No regulator can deliver enough current to prevent this problem if the load switch resistance is low and it is driven quickly. The only solution is to limit the rise time of the switch drive so that the load rise time is limited to approximately  $(25 \cdot C_{LOAD})$ .

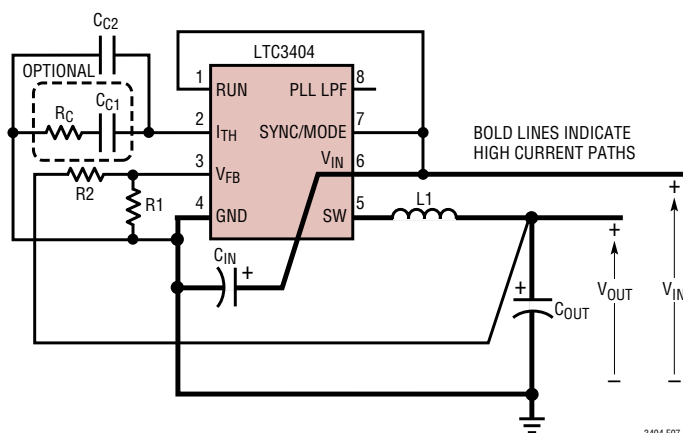

Figure 7. LTC3404 Layout Diagram

Thus, a 10 $\mu F$  capacitor charging to 3.3V would require a 250 $\mu s$  rise time, limiting the charging current to about 130mA.

### PC Board Layout Checklist

When laying out the printed circuit board, the following checklist should be used to ensure proper operation of the LTC3404. These items are also illustrated graphically in the layout diagram of Figure 7. Check the following in your layout:

1. Are the signal and power grounds segregated? The LTC3404 signal ground consists of the resistive divider, the optional compensation network ( $R_C$  and  $C_{C1}$ ) and  $C_{C2}$ . The power ground consists of the (-) plate of  $C_{IN}$ , the (-) plate of  $C_{OUT}$  and Pin 4 of the LTC3404. The power ground traces should be kept short, direct and wide. The signal ground and power ground should converge to a common node in a star-ground configuration.
2. Does the  $V_{FB}$  pin connect directly to the feedback resistors? The resistive divider  $R1/R2$  must be connected between the (+) plate of  $C_{OUT}$  and signal ground.
3. Does the (+) plate of  $C_{IN}$  connect to  $V_{IN}$  as closely as possible? This capacitor provides the AC current to the internal power MOSFETs.
4. Keep the switching node SW away from sensitive small signal nodes.

### Design Example

As a design example, assume the LTC3404 is used in a single lithium-ion battery-powered cellular phone application. The input voltage will be operating from a maximum of 4.2V down to about 2.7V. The load current requirement is a maximum of 0.3A but most of the time it will be in standby mode, requiring only 2mA. Efficiency at both low and high load currents is important. Output voltage is 2.5V. With this information we can calculate L using equation (1),

$$L = \frac{1}{(f)(\Delta I_L)} V_{OUT} \left( 1 - \frac{V_{OUT}}{V_{IN}} \right) \quad (3)$$

## APPLICATIONS INFORMATION

Substituting  $V_{OUT} = 2.5V$ ,  $V_{IN} = 4.2V$ ,  $\Delta I_L = 120mA$  and  $f = 1.4MHz$  in equation (3) gives:

$$L = \frac{2.5V}{1.4MHz(120mA)} \left( 1 - \frac{2.5V}{4.2V} \right) = 6\mu H$$

A 6.2μH inductor works well for this application. For best efficiency choose a 1A inductor with less than 0.25Ω series resistance.

$C_{IN}$  will require an RMS current rating of at least 0.15A at temperature and  $C_{OUT}$  will require an ESR of less than

0.25Ω. In most applications, the requirements for these capacitors are fairly similar.

For the feedback resistors, choose  $R1 = 412k$ .  $R2$  can then be calculated from equation (2) to be:

$$R2 = \left( \frac{V_{OUT}}{0.8} - 1 \right) R1 = 875.5k; \text{ use } 887k$$

Figure 8 shows the complete circuit along with its efficiency curve.

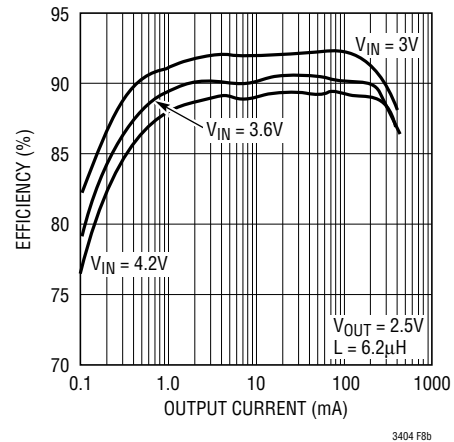
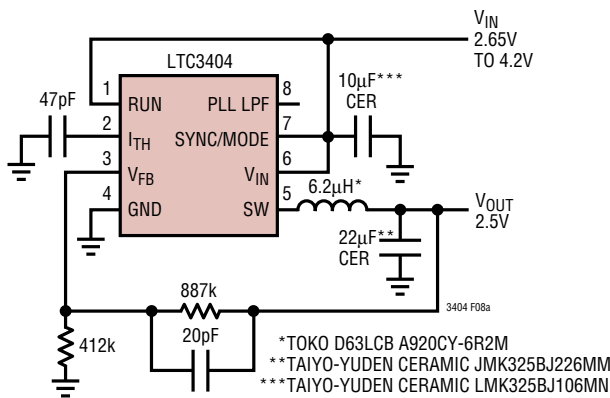
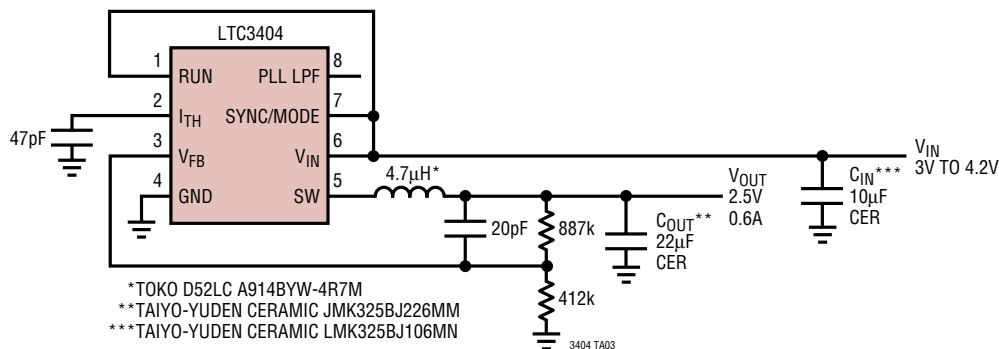

Figure 8. Single Lithium-Ion to 2.5V/0.3A Regulator from Design Example

## TYPICAL APPLICATIONS

### Single Li-Ion to 2.5V/0.6A Regulator Using All Ceramic Capacitors



# TYPICAL APPLICATIONS

## 3- to 4-Cell NiCd/NiMH to 1.8V/0.5A Regulator Using All Ceramic Capacitors

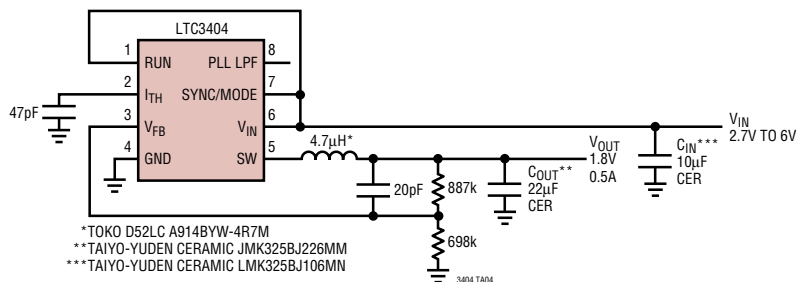

## Externally Synchronized 2.5V/0.6A Regulator Using All Ceramic Capacitors

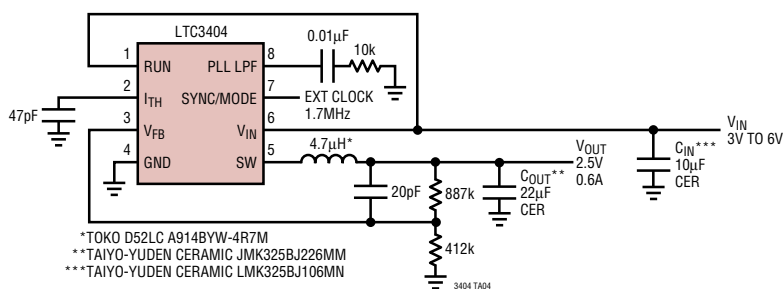

## Low Noise 2.5V/0.3A Regulator

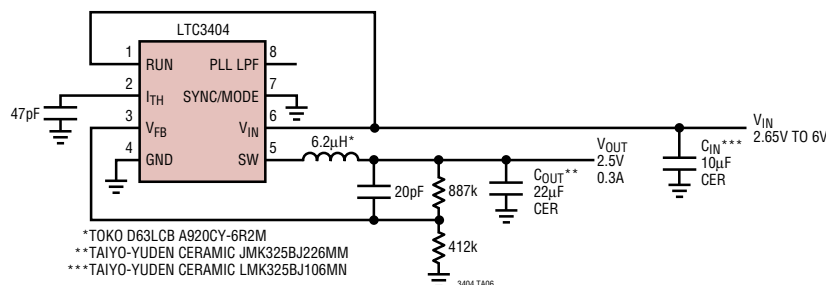

# PACKAGE DESCRIPTION

## MS8 Package 8-Lead Plastic MSOP (LTC DWG # 05-08-1660 Rev F)

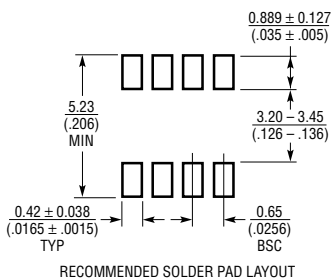

- NOTE:
1. DIMENSIONS IN MILLIMETER/(INCH)
  2. DRAWING NOT TO SCALE
  3. DIMENSION DOES NOT INCLUDE MOLD FLASH, PROTRUSIONS OR GATE BURRS.  
MOLD FLASH, PROTRUSIONS OR GATE BURRS SHALL NOT EXCEED 0.152mm (.006") PER SIDE

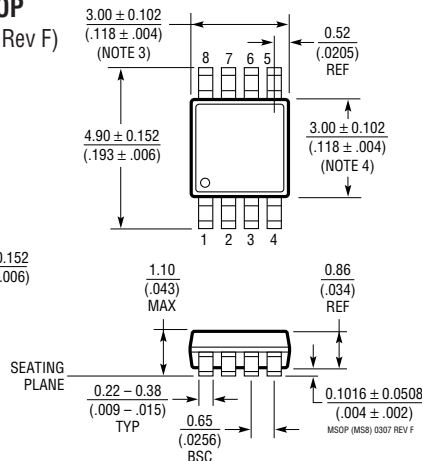
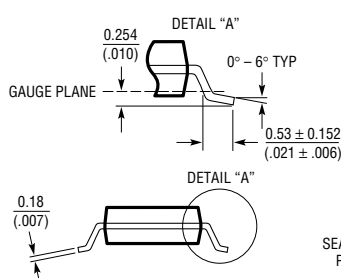

4. DIMENSION DOES NOT INCLUDE INTERLEAD FLASH OR PROTRUSIONS.  
INTERLEAD FLASH OR PROTRUSIONS SHALL NOT EXCEED 0.152mm (.006") PER SIDE
5. LEAD COPLANARITY (BOTTOM OF LEADS AFTER FORMING) SHALL BE 0.102mm (.004") MAX

